



agriculture & rural development

Department:
agriculture
& rural development
PROVINCE OF KWAZULU-NATAL

Onion production



Compiled by the Directorate Communication,
National Department of Agriculture and
W. Willemse,
KwaZulu-Natal Department of Agriculture
Illustrations by
L. Herbst, Mjindi Farming (Pty) Ltd



ISBN 1-86871-011-4

Preparing the land for onions

1. Irrigate the land if it is dry

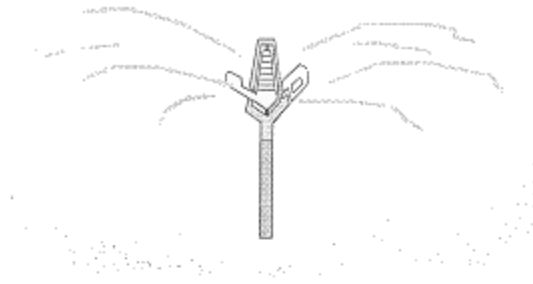

2. It may be necessary to rip the field

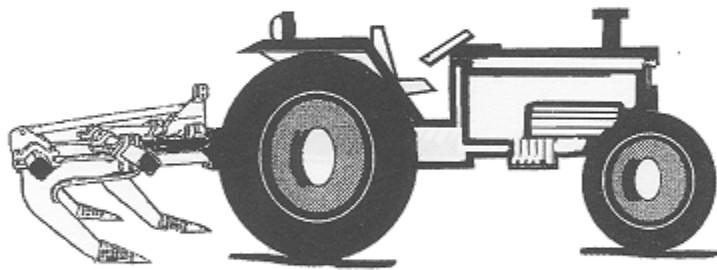

3. Turn up (plough) the soil in the field

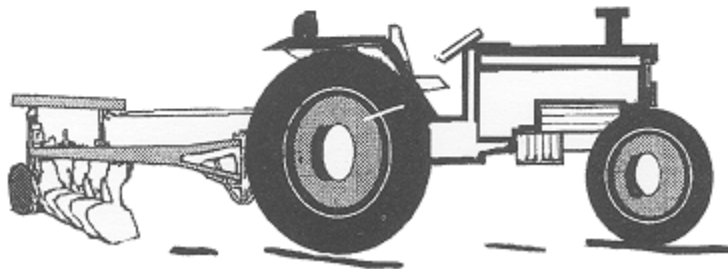

4. Disc the field

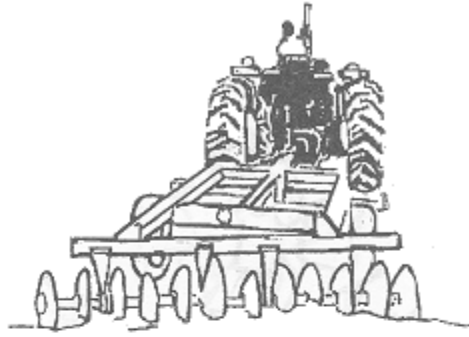

5. Draw furrows (ridges) in the field

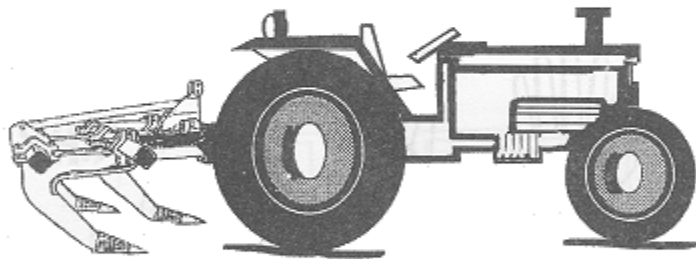

6. The spacing between the rows must be between 20 to 40 cm

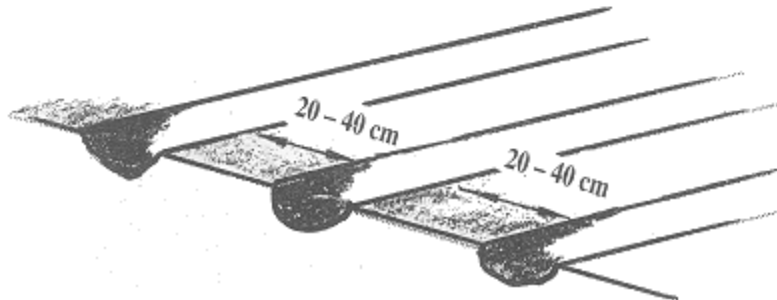

Fertilizing

1. Apply fertiliser to the soil before planting



2. Use about six bags of MAP fertiliser per hectare



3. Use a hoe to cover the fertiliser with soil



Planting

1. Lay seedlings down and cover their roots with soil



2. Spacing between the seedlings must be about 5 to 10 cm
(size of 1 or 2 matchboxes)

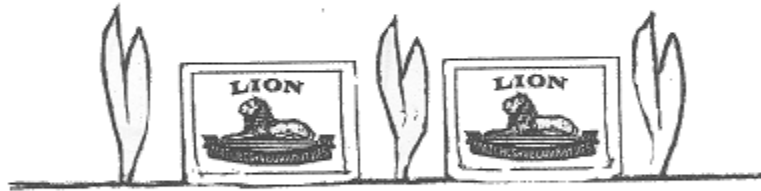

3. Irrigate the field after planting

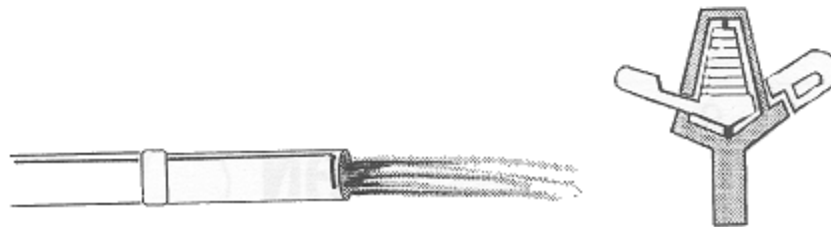

Topdressing

Apply topdressing 6 weeks after planting



Application:

1 bag UREA per hectare

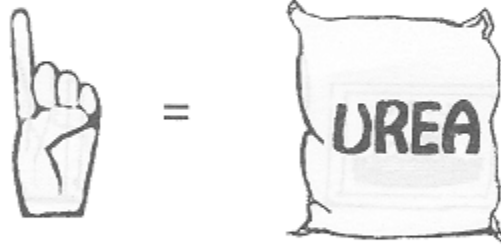









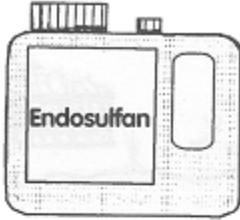
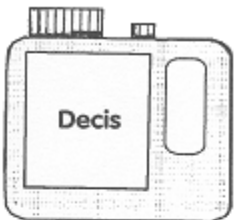

or

2 bags of LAN per hectare

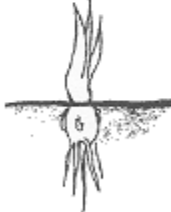

Pests and diseases

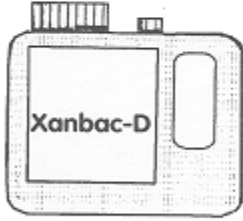
Pest	Treatment
<p>Thrips</p> 	  or 

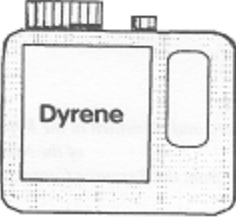
Disease	Treatment
<p>Downy mildew</p> 	 
<p>White bulb rot</p> 	 
<p>Purple blotch</p> 	 

Harvesting

1. You can harvest onions 180 to 230 days (6 to 8 months) after planting



2. When the leaves are yellow and fall over, the onions are ready for harvesting



3. Put the onions in a dry, ventilated place after harvesting

